

Edgetech I.G. Spacer Systems

Insulating Glass Manufacturing Manual

(this page intentionally left blank)

Table of Contents

Desiccant Protection	3
Glass Cutting and Edge-Deleting	5
Glass Edge Characteristics	6
Glass Washing	7
Edgetech Spacer Systems Application Area	10
Super Shuttle Application Techniques	11
Euro Shuttle Application Techniques	15
TriSeal™ Application Techniques	19
Muntin-Grid Installation	23
Glass Matching Tips	28
Adhesive Whet-Out and TriSeal™ PIB	29
Super Spacer Roller Press Settings Guide	30
Gas Filling Guidelines	31
Secondary Sealant Application	35
TriSeal™ Sealant Application	37
Recommended Sealant Compatibility List	40
Workmanship	41
Quality Control Procedures	43
Breakdown Reels	48
Contact Information	49

Super Spacer® contains at least 40% by weight of desiccant material, and prior to unit fabrication, it is critical that this desiccant material is not preloaded with moisture.

1. Desiccant Activity Test Kit

Edgetech has a Desiccant Activity Test Kit available. The kit should be used for the following:

- First packages of each new lot.
- Previously opened packages of Super Spacer.
- Any unopened packages of Super Spacer older than 36 months.



Super Spacer that does not pass cannot be used for production.

2. Temporary Storage

Bulk Reels

To protect the desiccant material during shipment, Super Spacer is vacuum-sealed in a moisture-proof foil wrapping that is packaged within a polyethylene bag.

Once the foil wrapping is opened, the product should be used without undue delay.

If any unused material remains on the reel, the reel should be replaced in the polyethylene bag. Any air within the bag should be expelled. The bag should then be closed and stored elevated from the floor and away from any exterior walls for desiccant protection.



Flat Rolls

For low-volume or intermittent use, Super Spacer is also available in 66 ft. rolls that are packaged in moisture-proof foil bags.

Any unused material can be repackaged in the flat roll bags with the foil packaging being heat-sealed or taped for desiccant protection. The unused, repackaged material must be stored elevated from the floor and away from any exterior walls.



3. Reel stands with protective lids

For desiccant protection during spacer application, use reel stands with protective lids. These special Super Spacer stands are available in single, double and multi-reel designs.



4. Additional Protective Measures

When production is interrupted for more than 15 minutes, additional protective measures should be taken. For the Super Spacer reel stands, the reel slot should be closed and the material fully rewound on the reel.

Even with the reel slots closed, the reels must be removed from the stand if there is a prolonged delay. Specifically, reels should not be left overnight but removed from the stand and replaced in the polyethylene bags. The polyethylene bag with the reel should be stored elevated from the floor and away from any exterior walls.



5. Production Delays

Once the spacer has been applied, there can be no delay before glass matching.

Once the unit has been matched, apply the secondary sealant with minimal delay

Proper glass cutting is essential for quality and longevity of an IG unit. Proper glass cutting techniques generally tend to decrease the breakage potential resulting from edge imperfections.

1. Glass Cutting

- Use water-soluble cutting fluid.

Reference glasscutter's or glass manufacturer's recommendations.

- Inspect all glass edges to ensure a clean, straight cut.

Items to look for are scores, wings, convolutions, shark teeth, serration hackle (no more than 10%), flares, bevels, flake chips and rough chips.

- Use correct wheel angle, diameter and pressure.

This must be taken into consideration for maximum score quality.

- It is essential to use approved gloves when handling glass.

Follow glass manufacturer's recommendations.

- Cut soft coat Low-e glass with the coated surface up.

- Cut pyrolytic or hard coat Low-e glass with coated side down.

This type of coating does not require edge deleting.

2. Edge Deleting

- Follow manufacturer's recommendations.

Edge deleting is recommended on all Low-e soft coat glass; however, some insulating glass manufacturers have chosen not to edge delete. Always check with the glass manufacturer and sealant manufacturer for specific instructions on edge deleting. Reference Edgetech Technical Bulletin RD0007: Glass Cutting and Edge Deleting.

- Grinding operation

Grinding operation must take place with the coated surface face-up.

Top views of the sheets of glass



Score
Scratch made by the glass-cutting tool.



Wings
Glass flakes originating on each side of score. They may fly out under excessive wheel pressure.



Convolutions
Smooth rolling surfaces on edge of glass.



Shark Teeth
Dagger-like imperfections that start from scored surface. Breakage possibility increases as depth, roughness and number of shark teeth increase.



Serration Hackle
Edge imperfections, usually perpendicular to glass surface, which occur at surface opposite score. Breakage possibility increases as density and depth increase.



Flare
Sharp protrusion at junction of edge and glass surface.



Bevel
Edge that is not perpendicular to surfaces. (Formation of shark teeth, serration hackle, flare and bevel depend upon score opening technique.)



Flake Chips
Smooth shallow chips.



Rough Chips
Rough penetrating chips.

Views of the edge of glass

(Information taken from PRC seminar Testing Insulating Glass: How to Avoid Failures)

Inspect for cleanliness to ensure that the glass is completely clean, dry and contaminant free. This will ensure proper bonding of the spacer adhesive and secondary sealant to the glass.

1. Loading

- Load glass at an angle to air knives on horizontal washer.
- Remove labels before loading.
- When running Low-e glass through a horizontal washer, the glass should be run through the washer with the Low-e coating facing upward. When running Low-e through a vertical washer, the Low-e coating should be facing outward.
- Glass must move steadily past the washer brushes. If it is stopped under the rotating brushes, fine rub marks can be expected.

2. Water

Treatment

- Conditioned water such as RO, DI or de-mineralized water is recommended.

Temperature

- The industry guideline for wash water is $130^{\circ} \pm 10^{\circ}\text{F}$ / ($54^{\circ} \pm 6^{\circ}\text{C}$).
- Consult your glass supplier for wash temperature specification for specific glass type.

Detergent

- Check with your glass supplier and sealant supplier for approved commonly used glasswashing detergents. The use of heated wash water is the only method to effectively remove contaminants from the glass.

Rinse

- No foam should be present in the rinse tank.
- No detergents should be added to rinse tanks.
- Edgetech recommends that final rinse be fresh circulated or conditioned water such as RO, DI or de-mineralized.
- Softened water is not recommended for glass rinse water.

3. Drying

- Use clean filtered air. Change filters per the glass washer manufacturer's recommendation.
- No silicone or Teflon sprays are to be used in an IG manufacturing facility.

4. Glass Inspection

- Visually inspect for spotting, scratching or other markings.
- Edgetech recommends inspection lights at exit of washer.

5. Maintenance

- Daily, weekly and monthly preventive maintenance must be performed per the manufacturer's recommendations.

(this page intentionally left blank)

The Edgetech Spacer Systems I.G. application area should be as contaminant free as possible.

1. Climate Controlled Positive Pressure Clean Room

When applying Edgetech Spacer Systems, a climate controlled positive pressure clean room is highly recommended.

Reference Edgetech Technical Bulletin TS0003: Clean Rooms.

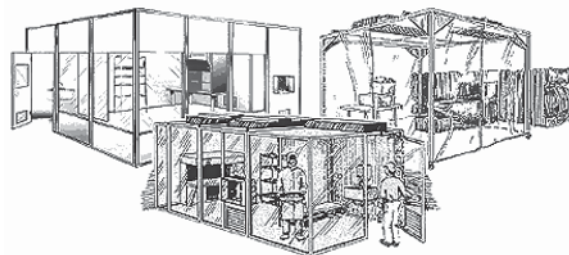

2. Lubricant Sprays

Do not use lubricant sprays in the same building when constructing I.G. units. Lubricant spray that gets on the glass may inhibit proper bonding of the sealant to the glass and may lead to seal failures. It is important to monitor and eliminate potential sources of contamination, such as smoking, near the application area.



3. Daily Housekeeping

Practice daily housekeeping procedures to help eliminate contaminants—cleaning all debris and dust from equipment and application area.



1. SuperShuttle: equipment setup

Edgetech's SuperShuttle is a pneumatically powered tool specifically developed for Super Spacer® application. Various guide blocks can be selected to accommodate different setback distances for secondary sealant.

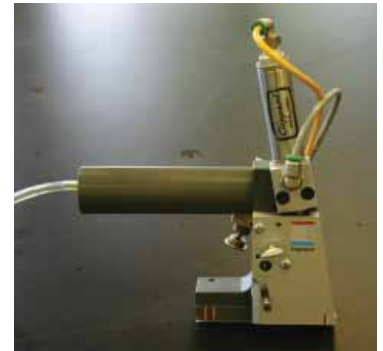

2. SuperShuttle: component parts

For the different spacer set-back distances, use the red X, Y, Z marks for 3/16" (4.76mm) set-back and the yellow X, Y, Z marks for 1/4" (6.35mm) set-back.

Legend:

- | | |
|--|--------------------------------|
| A Pressure wheel adjustment screw | F Notcher punch trigger |
| B Pressure wheel extension pin | G Notcher punch |
| C Guide roller | H Faceplate |
| D Pressure wheel | I Cutting blade trigger |
| E Guide block | |

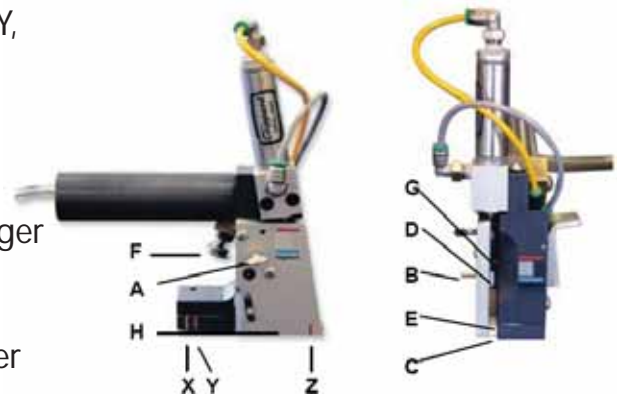

3. Liner Stripper

The Super Spacer Liner Stripper automatically strips the protective liner from one or both Super Spacer sides. For specific instruction on setup and use, consult the Liner Stripper operator's manual.



4. SuperShuttle: spacer-width adjustments

Edgetech's SuperShuttle can be used for Super Spacer sizes ranging from 3/16" (4.76mm) to 7/8" (22.2mm). For spacer width adjustments, loosen the pressure wheel adjustment screw **A** so that the pressure wheel extension pin **B** moves freely. With the foil surface facing the operator, insert spacer between guide roller **C** and pressure wheel **D**. Using extension pin **B**, position the pressure wheel **D** on the spacer so that the bottom spacer edge exceeds the tool base by about 1/32" (0.8mm).

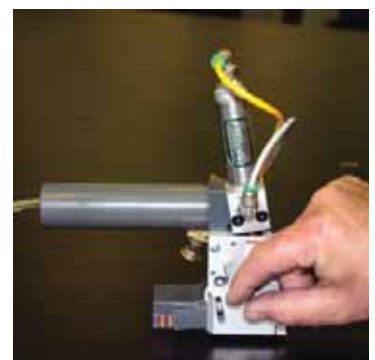

5. Start-up: pre-notching spacer end

When a new reel is being used, the spacer must be pre-notched and sliced. With the Mylar surface facing the SuperShuttle, pull the spacer through so that it extends beyond the base of the tool. With thumb of right hand, press cutting blade trigger **I**. Once engaged, activate notcher punch trigger **F** to set in motion the notcher punch **G** and remove waste spacer material.

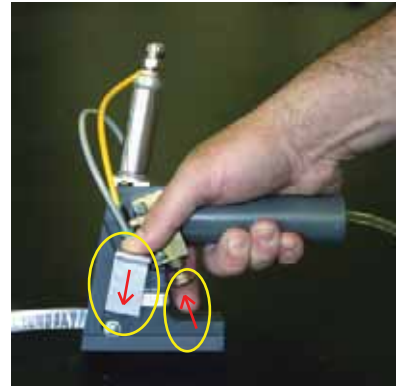

6. First corner: start-up

Place guide block **E** against the side of the first glass lite and align mark **X** with the starting corner. Line up spacer end with mark **Y** and tack down by applying pressure with one finger of right hand.

Red marks at X and Y are for use with the 3/16" guide block.
Yellow marks at X and Y are for use with the 1/4" guide block.

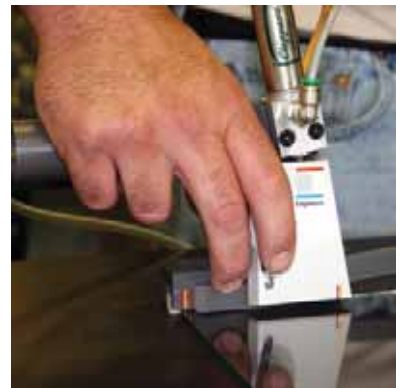

7. First side: spacer application

Using left hand, support the spacer slightly above glass surface. While maintaining the tape perpendicular to the glass, apply a slight downward pressure and glide the tool along the glass edge toward the second corner.



8. Second corner: spacer notching

Glide the tool along the glass edge until mark **Z** aligns with the upcoming corner. Activate notcher punch trigger **F** to engage the notcher punch **G**.

Red marks at Z are for use with the 3/16" guide block.
Yellow marks at Z are for use with the 1/4" guide block.



9. Second corner: glass rotation

Activate the table-indexing mechanism, and be sure to keep tool in place as the glass is rotated through 90°.

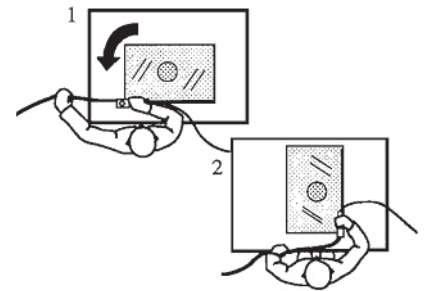

10. Second corner: spacer adhesion

Continue moving the tool straight ahead until the left side of the notch is aligned with the edge of the faceplate **H**. With one finger from right hand, press down on spacer to ensure good adhesion.

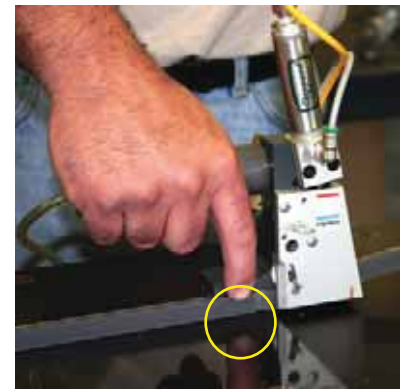

11. Second corner: tool advancement

Advance tool approximately 1½" (40mm) beyond corner notch.

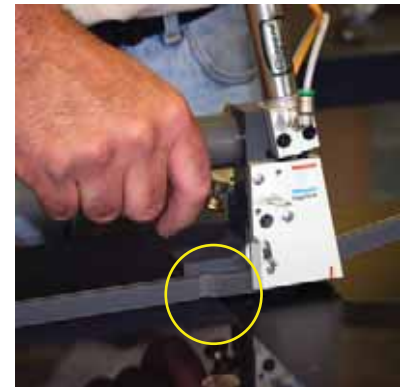

12. Second corner: guide-block placement

While holding the spacer against the tool base with one finger, tilt tool so that front end is approximately 1/4" (6mm) above glass surface. Without moving the tool forward and without pulling on the spacer, pivot the tool until the guide block **E** meets the glass edge.



13. Second corner: spacer adhesion

Move finger to top edge, and tack down spacer at about a 1" (25mm) distance from corner. Proceed with spacer application, repeating steps 8 through 13 at third and fourth corners.

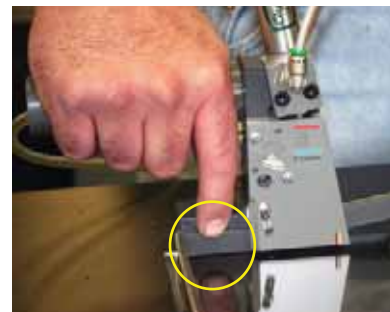

14. Final corner: spacer cut-off

At a point approximately 1" (25mm) from the final corner, guide the tool slightly upward to avoid hitting the starting end of the spacer. Advance tool until mark **Z** aligns with the corner edge of glass. Activate notcher punch trigger **F** to set in motion the notcher punch **G**, and remove tool by pulling it forward and off the previously applied spacer.

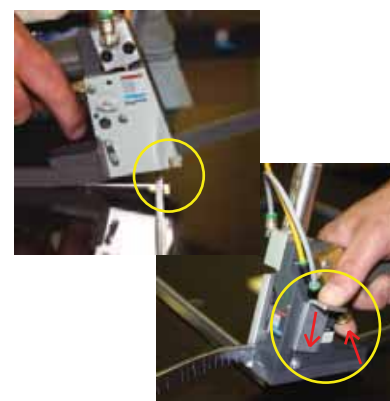

15. Final corner: tape application

Manually align the two spacer ends to form the final corner joint. For gas filled units, wrap about a 1" (25mm) length of approved barrier tape over the final joint, and apply pressure to ensure good adhesion. Make certain that the barrier tape does not roll up on the glass.



Good Application Quality

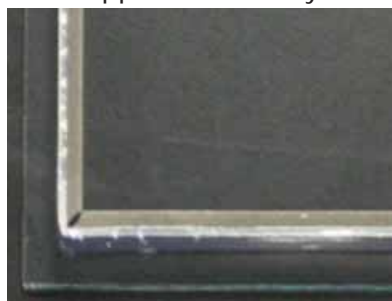

Proper Tape Application Quality



Poor Tape Application Quality



1. Euro Shuttle: equipment setup

Edgetech's Euro Shuttle is a pneumatically powered tool specifically developed for Super Spacer® application. Various guide blocks can be selected to accommodate different setback distances for secondary sealant.



2. Euro Shuttle: component parts

For the different spacer set-back distances, use the red **X, Y, Z** marks for 3/16" (4.76mm) set-back and the yellow **X, Y, Z** marks for 1/4" (6.35mm) set-back.

Legend:

- | | |
|--|--------------------------------|
| A Pressure wheel adjustment screw | F Notcher Blade trigger |
| B Pressure wheel extension pin | G Notcher Blade |
| C Guide roller | H Faceplate |
| D Pressure wheel | I Cutting trigger |
| E Guide block | |

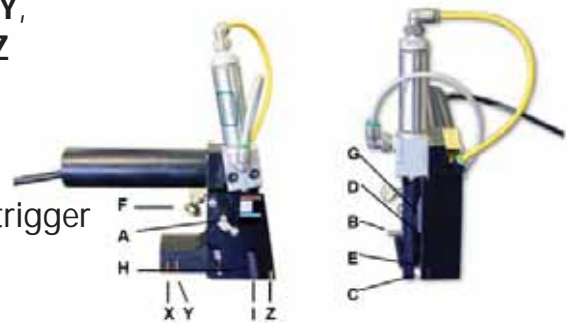

3. Liner Stripper

The Super Spacer Liner Stripper automatically strips the protective liner from one or both Super Spacer sides. For specific instruction on setup and use, consult the Liner Stripper operator's manual.



4. Euro Shuttle: spacer-width adjustments

Edgetech's Euro Shuttle can be used for Super Spacer sizes ranging from 3/16" (4.76mm) to 7/8" (22.2mm). For spacer width adjustments, loosen the pressure wheel adjustment screw **A** so that the pressure wheel extension pin **B** moves freely. With the foil surface facing the operator, insert spacer between guide roller **C** and pressure wheel **D**. Using extension pin **B**, position the pressure wheel **D** on the spacer so that the bottom spacer edge exceeds the tool base by about 1/32" (0.8mm).



5. Start-up: pre-notching spacer end

When a new reel is being used, the spacer must be cut square. With the Mylar surface facing the Euro Shuttle, pull the spacer through so that it extends beyond the base of the tool. With left hand, press cutting trigger **I**. Once engaged, activate notcher blade trigger **F** to set in motion the notcher blade **G** and remove waste spacer material.

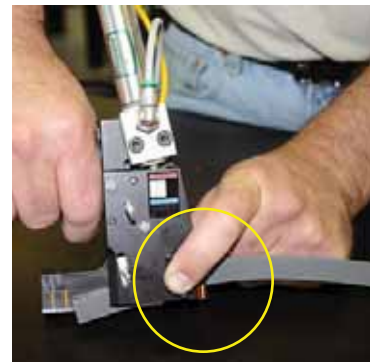

6. First corner: start-up

Place guide block **E** against the side of the first glass lite and align mark **X** with the starting corner. Line up spacer end with mark **Y** and tack down by applying pressure with one finger of right hand.

Red marks at **X** and **Y** are for use with the 3/16" guide block.
Yellow marks at **X** and **Y** are for use with the 1/4" guide block.



7. First side: spacer application

Using left hand, support the spacer slightly above glass surface. While maintaining the tape perpendicular to the glass, apply a slight downward pressure and glide the tool along the glass edge toward the second corner.



8. Second corner: spacer notching

Glide the tool along the glass edge until mark **Z** aligns with the upcoming corner. Activate notcher blade trigger **F** to engage the notcher blade **G**.

Red marks at **Z** are for use with the 3/16" guide block.
Yellow marks at **Z** are for use with the 1/4" guide block.



9. Second corner: glass rotation

Activate the table-indexing mechanism, and be sure to keep tool in place as the glass is rotated through 90°.

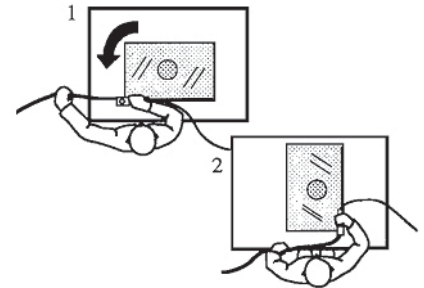

10. Second corner: spacer adhesion

Continue moving the tool straight ahead until the left side of the notch is aligned with the edge of the faceplate **H**. With one finger from right hand, press down on spacer to ensure good adhesion.



11. Second corner: tool advancement

Advance tool approximately 1½" (40mm) beyond corner notch.



12. Second corner: guide-block placement

While holding the spacer against the tool base with one finger, tilt tool so that front end is approximately 1/4" (6mm) above glass surface. Without moving the tool forward and without pulling on the spacer, pivot the tool until the guide block **E** meets the glass edge.

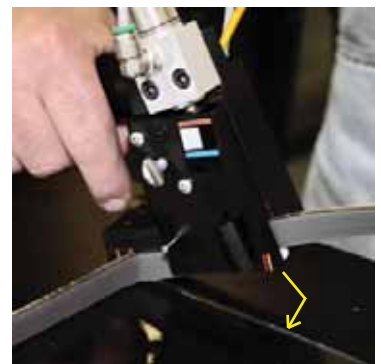

13. Second corner: spacer adhesion

Move finger to top edge, and tack down spacer at about a 1" (25mm) distance from corner. Proceed with spacer application, repeating steps 8 through 13 at third and fourth corners.



14. Final corner: spacer cut-off

At a point approximately 1" (25mm) from the final corner, guide the tool slightly upward to avoid hitting the starting end of the spacer. Advance tool until mark **Z** aligns with the corner edge of glass. Activate notcher blade trigger **F** to set in motion the notcher blade **G**, and remove tool by pulling it forward and off the previously applied spacer.



15. Final corner: tape application

Manually align the two spacer ends to form the final corner joint. For gas filled units, wrap about a 1" (25mm) length of approved barrier tape over the final joint, and apply pressure to ensure good adhesion. Make certain that the barrier tape does not roll up on the glass.

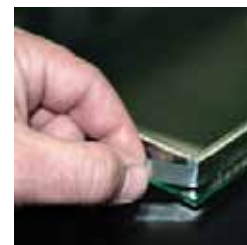

Good Euro Shuttle Application Quality



*Note – Best application occurs when temperature is between 65° F - 85° F (18.33° C - 29.44° C) and the product has equalized to that temperature for at least 8 hours.

1. TriSeal Shuttle: equipment setup

Edgetech's TriSeal Shuttle is a pneumatically powered tool specifically developed for TriSeal™ application. Various guide blocks can be selected to accommodate different setback distances for secondary sealant.

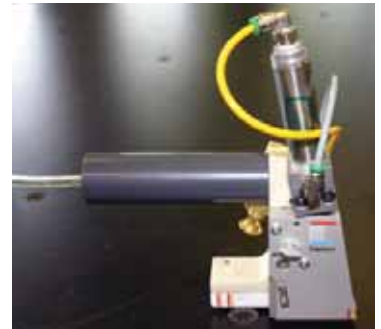

2. TriSeal Shuttle: component parts

For the different spacer set-back distances, use the red **X, Y, Z** marks for 3/16" (4.76mm) set-back and the yellow **X, Y, Z** marks for 1/4" (6.35mm) set-back.

Legend:

- | | |
|--|--------------------------------|
| A Pressure wheel adjustment screw | F Notcher punch trigger |
| B Pressure wheel extension pin | G Notcher punch |
| C Guide roller | H Faceplate |
| D Pressure wheel | I Cutting blade trigger |
| E Guide block | |

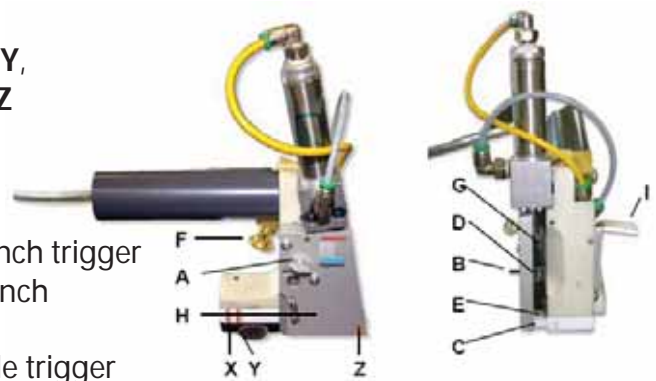

3. Liner Stripper

The Liner Stripper automatically strips the protective liner from TriSeal. For specific instruction on setup and use, consult the Liner Stripper operator's manual. The protective liner can be loaded on either cone as shown in the picture.



4. TriSeal Shuttle: spacer-width adjustments

Edgetech's TriSeal Shuttle can be used for TriSeal Spacer sizes ranging from 8.2mm to 22.2mm — in 2mm increments. For spacer width adjustments, loosen the pressure wheel adjustment screw **A** so that the pressure wheel extension pin **B** moves freely. With the foil surface facing the operator, insert spacer between guide roller **C** and pressure wheel **D**. Using extension pin **B**, position the pressure wheel **D** on the spacer so that the bottom spacer edge exceeds the tool base by about 1/32" (0.8mm).

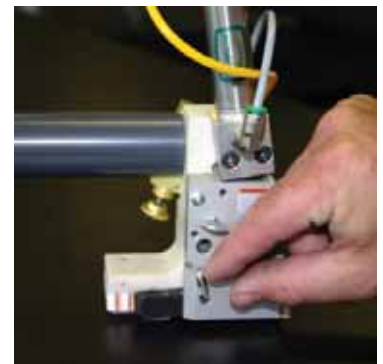

5. Start-up: pre-notching spacer end

When a new reel is being used, the spacer must be pre-notched and sliced. With the multi-layer vapor barrier surface facing the TriSeal Shuttle, pull the spacer through so that it extends beyond the base of the tool. With thumb of right hand, press cutting blade trigger **I**. Once engaged, activate notcher punch trigger **F** to set in motion the notcher punch **G** and remove waste spacer material.

*Correct punch depth into spacer: The punch should contact the edge of the PIB but not bite into the PIB.

Correct



Not Correct



6. First corner: start-up

Place guide block **E** against the side of the first glass lite and align mark **X** with the starting corner. Line up spacer end with mark **Y** and tack down by applying pressure with one finger of right hand.

Red marks at X and Y are for use with the 3/16" guide block.

Yellow marks at X and Y are for use with the 1/4" guide block.

7. First side: spacer application

Using left hand, support the spacer tape slightly above glass surface. While maintaining the tape perpendicular to the glass, apply a slight downward pressure and glide the tool along the glass edge toward the second corner.

8. Second corner: spacer notching

Glide the tool along the glass edge until mark **Z** aligns with the upcoming corner. Activate notcher punch trigger **F** to engage the notcher punch **G**.

Red marks at Z are for use with the 3/16" guide block.

Yellow marks at Z are for use with the 1/4" guide block.

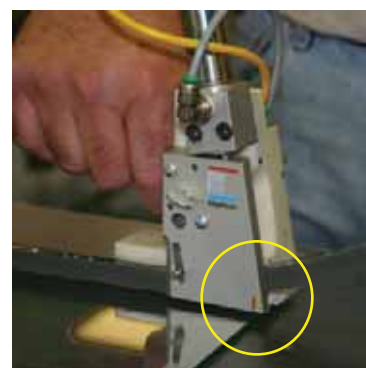
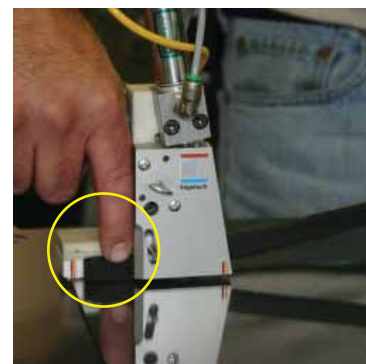
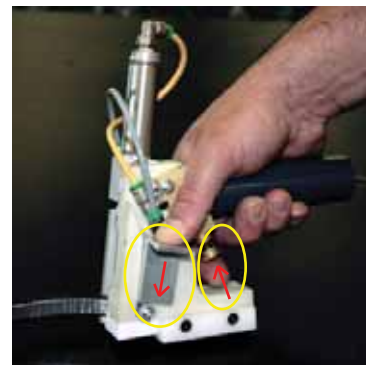

9. Second corner: glass rotation

Activate the table-indexing mechanism, and be sure to keep tool in place as the glass is rotated through 90°.

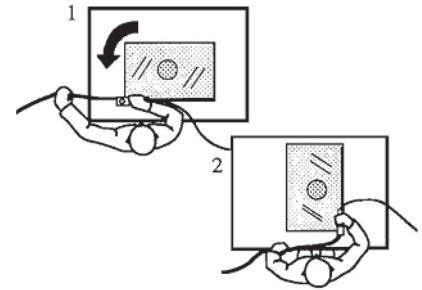

10. Second corner: spacer adhesion

Continue moving the tool straight ahead until the left side of the notch is aligned with the edge of the faceplate **H**. With one finger from right hand, press down on spacer to ensure good adhesion.



11. Second corner: tool advancement

Advance tool approximately 1½" (40mm) beyond corner notch.

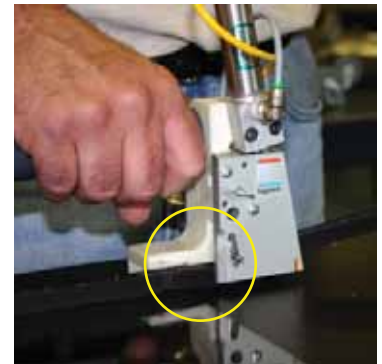

12. Second corner: guide-block placement

While holding the spacer against the tool base with one finger, tilt tool so that front end is approximately 1/4" (6mm) above glass surface. Without moving the tool forward and without pulling on the spacer, pivot the tool until the guide block **E** meets the glass edge.

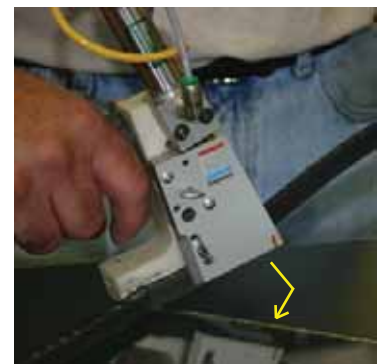

13. Second corner: spacer adhesion

Move finger to top edge, and tack down spacer at about a 1" (25mm) distance from corner. Proceed with spacer application, repeating steps 8 through 13 at third and fourth corners.

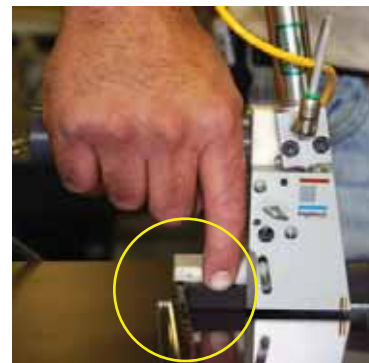

14. Final corner: spacer cut-off

At a point approximately 1" (25mm) from the final corner, tilt tool upward so that front end is above first side of spacer to avoid hitting the starting end of the spacer. Advance tool until mark Z aligns with the corner edge of glass. Notch and cut off spacer end as in step 5, and remove tool by pulling it forward and off the previously applied spacer.



15. Final corner: tape application - *Based upon testing, final corner sealing strips are mandatory for inert gas retention and resistance to moisture ingress.*

Manually align the two spacer ends to form the final corner joint.



*Ensure that the PIB extends to the corner so that there is no PIB void at the final corner.

Wrap about a 1" (25mm) length of approved barrier tape over the final joint, and apply pressure to ensure good adhesion. Make certain that the PIB tape does not roll up on the glass.



Good TriSeal Application Quality



1. Use of End Clips

For muntin-grid installation, special offset clips are used to position the pre-assembled grid midway between the two glass lites. Snap fitted into the hollow muntin-bar ends, the clips incorporate protruding tabs that allow the grid to be simply set down onto the applied Super Spacer®. The foam side adhesive firmly holds the tabs in position, and when the second glass lite is applied, the flexible foam slightly depresses—eliminating any point loading on the glass.

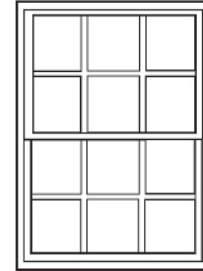

2. Selection of Appropriate End Clip

Clips are available in several models with various widths, offsets and sizes. Refer to the clip selection chart from your supplier.

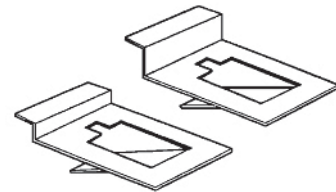

3. Installation of Clips

With the clip tab facing up, clips are inserted into the hollow ends of the pre-assembled muntin grid.

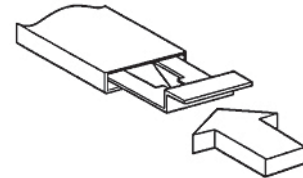

4. Muntin-Bar Alignment

For visual reasons, the muntin grid has to be carefully aligned with the muntin bars parallel to the glazing-unit sides. An important aid in carrying out this task is to use a grid pattern applied to the work surface. For small glazing units, one option is to apply a special custom grid pattern to the Super Spacer air-float table surface.

For large glazing units, because the operator is forced to lean over the table surface, horizontal tables are not suitable. It is recommended that either a vertical fixed-angle easel or Super Spacer Muntin-Grid Tilt Table be used.

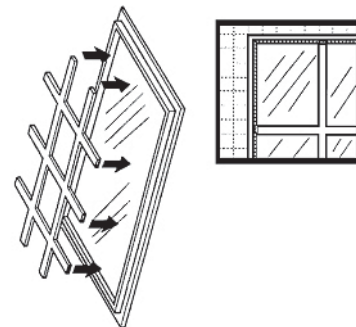

5. Fixed-Angle Easel

For muntin-grid alignment, Edgetech has developed a fixed angle easel that features a support ledge and a vertically sloped surface incorporating a square grid pattern. Because of the limitations of manual glass lifting, the matching easel is best suited for smaller glass lites.

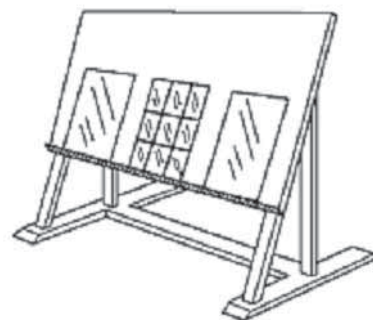

6. Muntin-Grid Tilt Table

Particularly useful for larger glass lites, the Super Spacer muntin-grid tilt table allows for Super Spacer edged glass lites to be simply air-floated into position over a uniform grid pattern surface. Air flotation is then reversed to hold the lite securely, and the table is quickly tilted to a preset angle for muntin insertion and/or matching the outboard lite. The table is then tilted back to the horizontal position, and the glass subassembly is air-floated onward to the Roller Press.

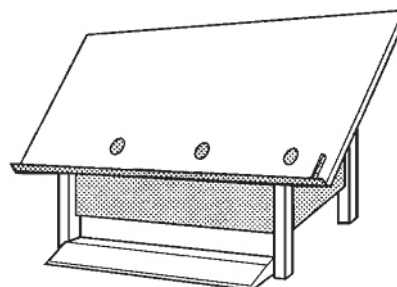

7. Pressed-in-Place Adhesion

Once the muntin-grid is correctly aligned and after checking to see that the clip shoulders are tight against the spacer wall, the clips are hand pressed in place.

The Super Spacer side adhesive holds the clips firmly in position and, even when passed through a roller press, the muntin grid remains correctly aligned.

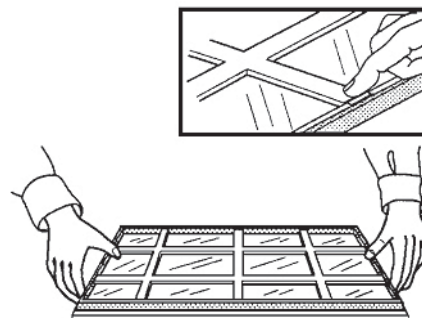

8. Muntin-Grid Cutback

Muntin-grids must be cut to the following formula: setback distance plus spacer width. Muntin-Grids must be cut to proper lengths. Muntin-Grids cut too long will bulge the spacer outward into the sealant bonding area.

9. Muntin-Grid Setback Blocks for Specialty Grids

To aid in cutting specialty grids to the proper lengths, Edgetech offers Muntin Setback Blocks. They are available in 2 different styles: 3/8" setback and 7/16" setback. The blocks contain a slot for SS glass and a slot for DS glass.

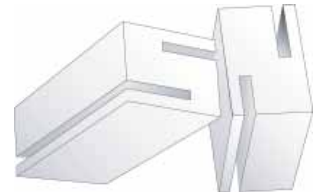

Once you have determined which blocks you need, place them over the edge of the glass using the proper glass size slot.

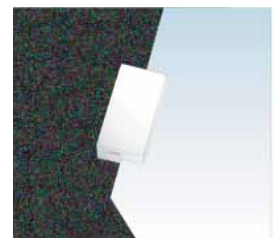

Once you place the blocks on the edges of the glass where needed, measure from inside to inside of the blocks. This will give you a measurement to cut your grids to.

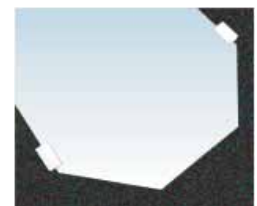

(this page intentionally left blank)

(this page intentionally left blank)

1. Glass Matching Tips

- In order to prevent contamination of the inside of the unit, match the second lite of an IG immediately after the spacer and grid have been applied.
- When using a matching easel or table, make sure all guides and stops are in good condition— check for wear and alignment.
- When checking a unit for alignment, check the two sides that contact the stops. Once the glass is aligned with the stops, check all other corners to ensure that the glass is cut evenly.
- Square and evenly aligned glass is crucial to ensuring the manufactures recommended sealant depth.
- To avoid contamination, blow out any dust and dirt from the inside of the units with a clean and dry air jet.

Proper whet-out of the acrylic adhesive in a Super Spacer® unit is necessary for maximum gas retention, structural integrity and prevention of secondary sealant blow by. It is important to do a visual inspection of the adhesive to make sure it has been pressed out properly.

1. Compression Methods

Roller Press

Roller presses are an effective way to ensure that the unit has been consistently and evenly pressed out to properly activate the acrylic adhesive to the glass. As a reference, Edgetech suggest that units be compressed $.040 \pm .010$ (1.0 mm $\pm .25$ mm) below the actual thickness of the unit. A visual inspection (described below) is the only way to be sure you are achieving proper whet-out.

By Hand

When pressing out by hand, press evenly and completely around the entire unit. Perform visual inspection to ensure proper whet-out.

2. Visual Inspection For Proper Whet-Out

The adhesive on the side of the spacer will appear darker after properly whet-out to the glass. The best way to check this is to compress the edge of the glass by hand and watch for a change in shade. If a change is noted, increase compression and then re-check.

TriSeal™ PIB and Adhesive Whet-Out

Proper whet-out of the PIB and acrylic adhesive in a TriSeal unit is necessary for maximum gas retention, structural integrity and prevention of secondary sealant blow by. It is important to do a visual inspection of the adhesive to make sure it has been pressed out properly.

1. Compression Methods

Roller Press

Roller presses are an effective way to ensure that the unit has been consistently and evenly pressed out to properly activate the acrylic adhesive to the glass. As a reference, Edgetech suggest that units be compressed $.030 \pm .010$ below the actual thickness of the unit. A visual inspection (described below) is the only way to be sure you are achieving proper whet-out.

2. Visual Inspection For Proper Whet-Out

The PIB and adhesive on the side of the spacer will appear darker after properly whet-out to the glass. The best way to check this is to compress the edge of the glass by hand and watch for a change in shade. If a change is noted, increase compression and then recheck.

Super Spacer Roller Press Settings Guide--INCHES

1 of 1

Find the overall thickness in column 1 or 3 and set the press at the column 2 or 4 number

Example: For 1 inch overall unit thickness, the press should be set at .960 inches.

1 OVERALL INCHES	2 SETTING INCHES	3 OVERALL INCHES	4 SETTING INCHES
3/8	0.33	1-7/32	1.17
5/16	0.27	1-1/4	1.21
7/16	0.39	1-9/32	1.24
1/2	0.46	1-5/16	1.27
17/32	0.49	1-11/32	1.30
9/16	0.52	1-3/8	1.33
19/32	0.55	1-13/32	1.36
5/8	0.58	1-7/16	1.39
21/32	0.61	1-15/32	1.42
11/16	0.64	1-1/2	1.46
23/32	0.67	1-17/32	1.49
3/4	0.71	1-9/16	1.52
25/32	0.74	1-19/32	1.55
13/16	0.77	1-5/8	1.58
27/32	0.80	1-21/32	1.61
7/8	0.83	1-11/16	1.64
29/32	0.86	1-23/32	1.67
15/16	0.89	1-3/4	1.71
31/32	0.92	1-25/32	1.74
1	0.96	1-13/16	1.77
1-1/32	0.95	1-27/32	1.80
1-1/16	1.02	1-7/8	1.83
1-3/32	1.05	1-29/32	1.86
1-1/8	1.08	1-15/16	1.89
1-5/32	1.11	1-31/32	1.92
1-3/16	1.14	2	1.96

1. Recommended Gas-Fill Equipment

With Super Shop production, lance gas-filling methods are typically used, and sensor fillers are specifically recommended. Compared to the less expensive time fillers, sensor or sniffer fillers have the two key advantages of consistent high fill and minimum wasted gas. In operation, sensor fillers continuously monitor the exhaust gas stream and automatically shut off when fill-gas concentration is above a minimum specified level (e.g. 95 %.)

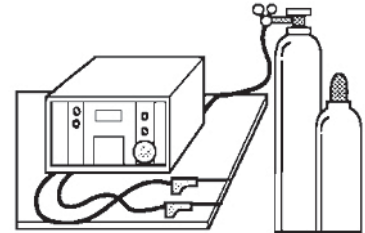

2. Different Types of Sensor Fillers

Sensor fillers can be classified into slow-fill or high-speed systems.

Slow-fill Equipment

With slow-fill equipment, air is pushed out of the glazing cavity by the heavier incoming inert gas. The key to efficient gas filling is a laminar flow input lance.

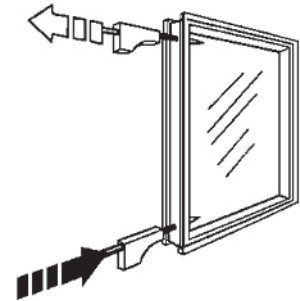

High Speed Equipment

With high-speed equipment, air is exhausted from the cavity by means of a vacuum pump, so the incoming gas is both sucked and pushed into the glazing cavity. To ensure that there is no danger of unit implosion or explosion, the equipment incorporates sophisticated computer controls. Also as with slowfill equipment, laminar flow input lances are critical for efficient gas filling.

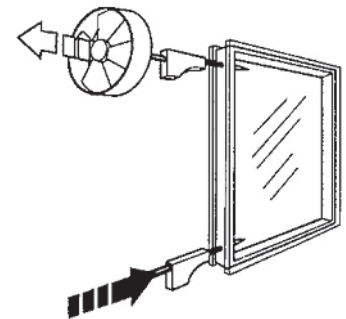

3. Importance of Large Diameter Holes

With Edgetech Spacer Systems, it is feasible to punch somewhat larger holes than with metal spacers. In the case of slow-fill equipment, these larger holes provide for increased capacity and efficiency. For high-speed equipment, these larger holes allow for on-line gas filling with resulting increased labor productivity.

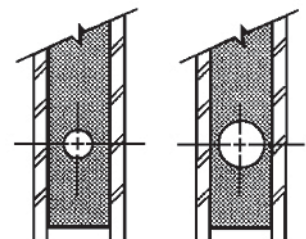

4. Gas-Fill Holes

Conventional Location

Typically, both the fill and exhaust holes are on one of the two longest sides and located within 1" (25 mm) of the top and bottom corners.

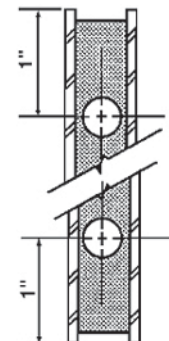

5. Production Flow

Typically, gas filling is carried out as an off-line batch process with the glass units in a vertical or tilt position. Given that with automated sealant gunning and Super Shop production glasstransfer is horizontal, this means that the units have to be vertically stacked, gas-filled and then individually fed to the automated gunning system. Prior to gas filling, the spacer's adhesive must be completely "whet-out" using a roller press or equivalent.

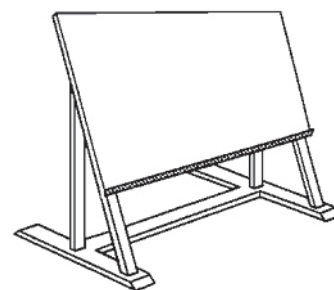

Double Sniffler

A further option for high-speed gas fillers is to incorporate two exhaust holes. This can significantly increase gas-fill speeds so that on-line gas filling is potentially feasible.

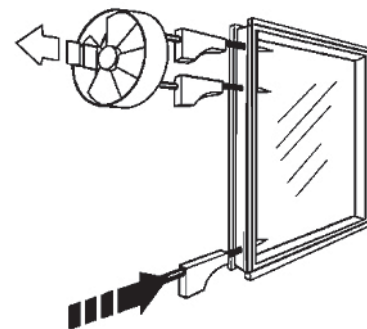

Horizontal Gas Filling

Some models of argon-filling equipment are now available with the option to fill I.G. units in the horizontal plane. This option reduces the number of handling steps per I.G. unit.

6. FDR Piercing Device

A special spacer piercing tool and bushing are available from FDR Design Inc. The awl-like tool pierces the spacer and installs a removable metal sleeve through which the sniffler and filling lances can be inserted. After the metal sleeve is removed, the flexible foam springs back leaving no visible holes in the spacer.

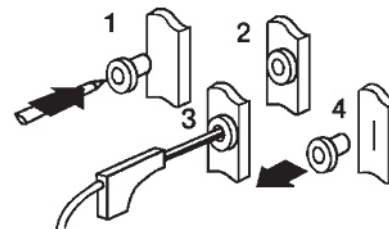

6. FDR Piercing Device *continued...*

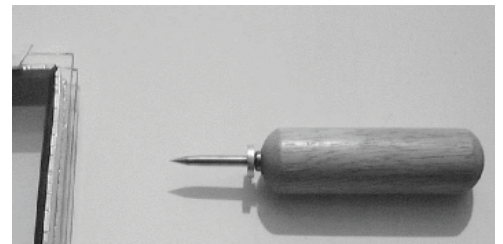
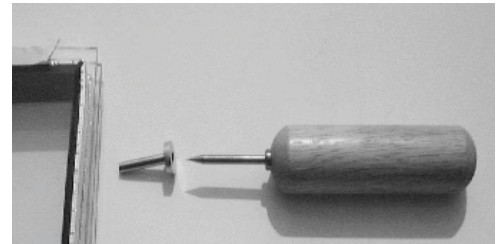

7. Super Spacer Notching Kit (does not apply to TriSeal™)

As an alternative to spacer piercing, a hole punching method may be used. The SuperShuttle notching kit is recommended. The pneumatic notcher punch makes a clean, precise and tapered hole, eliminating any debris from getting into the insulating glass unit. The standard diameter size hole for the gas notcher is 3-mm. Custom large-hole notching kits are also available.

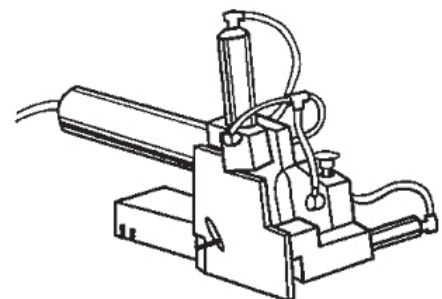

8. Tape Sealing of Gas-Fill Holes with approved barrier tape

After gas filling, the gas-fill holes must be immediately sealed and one recommended method is to use 1" lengths of approved barrier tape. To "whet-out" the tape adhesive, hand pressure must be applied to ensure an adequate seal. Edgetech provides rolls of barrier-film tape in various widths. The barrier film tape must be applied to the spacer only and should not roll up on the glass surfaces.

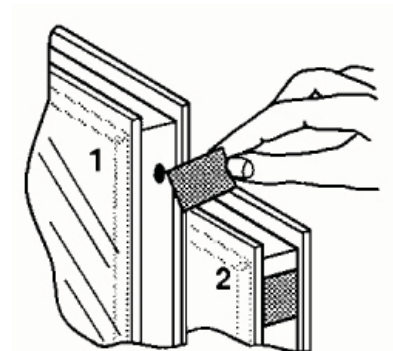

1. Place the IG unit vertically.
2. Make your piercing and insert the bushing.
3. Fill the unit with gas and remove the bushing.
4. Hold the tape lengthwise and work from the top. Put the bottom of the tape on the spacer and let it grab. For gas fill holes, you do not need the same size tape, just something to cover the holes.
5. Smooth the tape with the tweezers.
6. This can also be done with the final corner the same way. Work from the top and put the bottom section on first. Use the tweezers to smooth the tape.

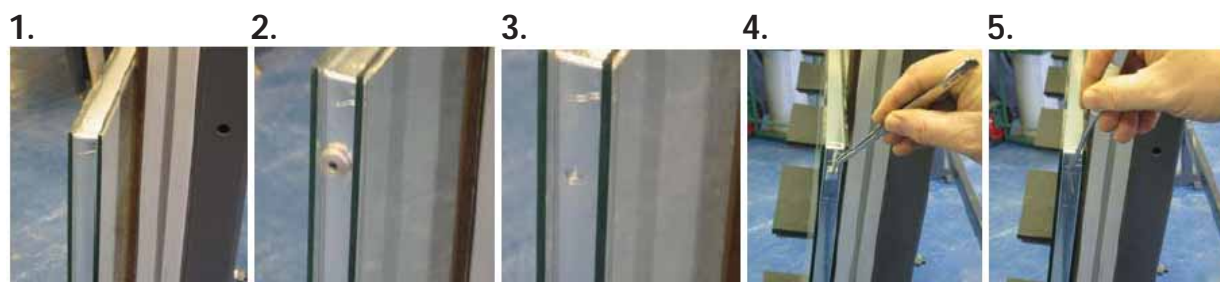

9. Alternative Sealing Method (does not apply to TriSeal™)

Butyl Plug

An alternative is to use a plug of hot melt butyl that is injected using a glue-gun type tool with an appropriate-sized nozzle. Although a fast production method, care is needed to prevent the butyl from being directly squirted into the glazing cavity.

10. Do Not Delay Before Sealant Gunning

After sealing the gas-fill holes, the secondary sealant should be applied immediately.

An approved Insulating Glass Secondary Sealant must be used with Super Spacer®. The secondary sealant provides a moisture vapor and gas vapor seal in a reverse dual seal Super Spacer IG unit. Edgetech recommends a secondary sealant with a low moisture vapor transmission rate (MVTR) to ensure low transmission of moisture vapor into the IG cavity and optimal gas retention.

1. Edgetech Approved Sealant Types

An easy to read chart listing manufacturers and approved products can be found on the final page of this section. It is titled "Insulating Glass Sealant Types for Edgetech Spacer Systems." Silicone is not an approved stand-alone secondary seal with Super Spacer.

2. Manufacturers Specifications

Always follow the sealant manufacturers specifications for temperatures, mix ratios, tooling, corner treatment, cure and cut apart times, etc.

3. Personal Protective Equipment

Always wear appropriate personal protective equipment when applying or working with secondary sealants.

4. Temperatures (Hot/Warm Applied Sealants)

Apply hot melt sealants at the manufacturer's recommended application temperature.

- If the sealant is too cold, poor adhesion to the glass and spacer will occur.
- If the sealant is too hot, thermal degradation of the sealant will occur along with slumping and stringing.

Check the sealant application temperature daily with a thermometer; do not rely on your machine's temperature sensors as they may be out of calibration.

Once units are matched, apply secondary sealants without delay. After gas filling, seal units immediately.

Seal one unit at a time, sealing completely around the unit without stopping. This will minimize the potential for cold joints.

Use a minimum of 3/16" (4.7mm) thick sealant behind the spacer when hot melt butyls are used.

5. Mix Ratio (Two Part Sealants)

Check the mix ratio daily and apply the sealant per the manufacturers recommendations.

Units sealed with two part sealants can be stacked; however, Edgetech recommends sealing without delay once the units have been matched.

Apply a ¼" (6.3mm) thick sealant amount behind the spacer when Polyurethanes or solvent-free Polysulfides are used.

6. Contamination

Absolutely no dust, dirt, Mylar tape roll-up or other contaminants should be present on the glass in the sealant bond line area. All secondary sealants are designed to adhere to clean dry glass only. Remove any debris before sealant application.

7. Corners

The corners of any insulating glass unit are very critical areas. Special attention must be given to ensure quality. Visually inspect and use Edgetech hot melt pads to pack the corners and remove voids, skips or cold joints.

8. Secondary Sealant Quality Checks

Absolutely no blow bys, cold joints or voids should be in the sealant. Visually inspect for defects in the sealant and correct them. Care should be taken not to damage glass edges when applying sealants.

Correctly Sealed Unit

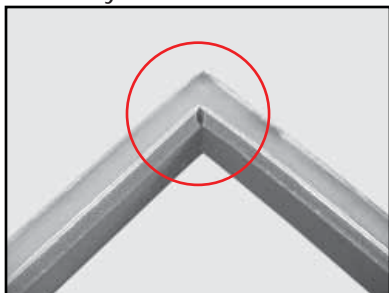

Correct - Euro Corner

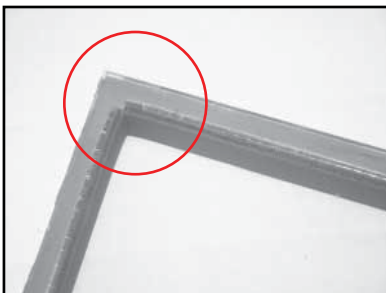

Blow by

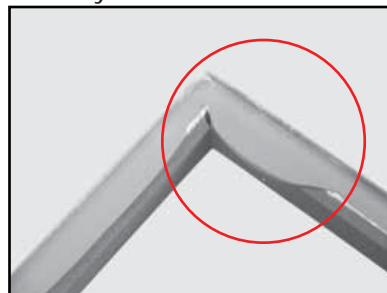

Cold Joint

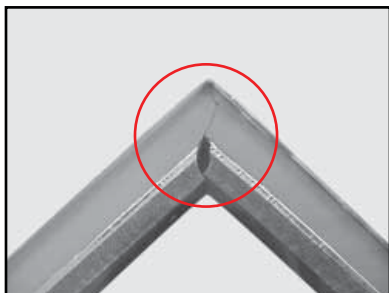

Cold Joint - Euro Corner

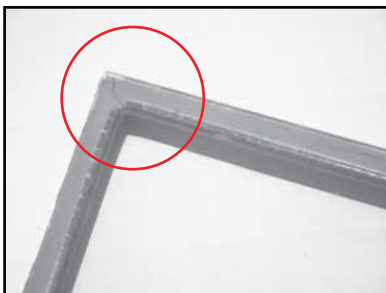

Void

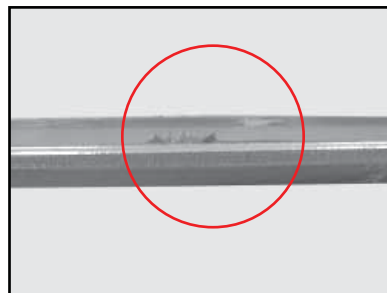

Correct final corner sealant packaging



Sealant Application Quality Along the Edge of Glass

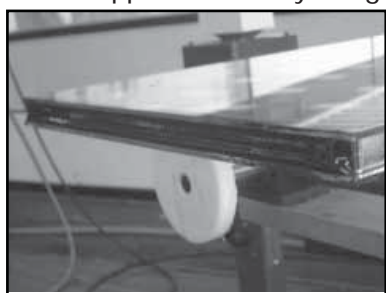

An approved Insulating Glass Sealant must be used with TriSeal. Industry approved silicone sealant must be used for TriSeal units made for structural glazing applications.

1. Edgetech Approved Sealant Types

An easy to read chart listing manufacturers and approved products can be found on the final page of this Secondary Sealant Application document. It is titled "Insulating Glass Sealant Types for Edgetech Spacer Systems." Silicone can be used with TriSeal.

2. Manufacturers Specifications

Always follow the sealant manufacturers specifications for temperatures, mix ratios, tooling, corner treatment, cure and cut apart times, etc.

3. Personal Protective Equipment

Always wear appropriate personal protective equipment when applying or working with secondary sealants.

4. Temperatures (Hot/Warm Applied Sealants)

Apply hot melt sealants at the manufacturer's recommended application temperature.

- If the sealant is too cold, poor adhesion to the glass and spacer will occur.
- If the sealant is too hot, thermal degradation of the sealant will occur along with slumping and stringing.

Check the sealant application temperature daily with a thermometer; do not rely on your machine's temperature sensors as they may be out of calibration.

Once units are matched, apply secondary sealants without delay. After gas filling, seal units immediately.

Seal one unit at a time, sealing completely around the unit without stopping. This will minimize the potential for cold joints.

Use a minimum of 3/16" (4.7mm) thick sealant behind the spacer when hot melt butyls are used.

5. Mix Ratio (Two Part Sealants)

Check the mix ratio daily and apply the sealant per the manufacturers recommendations. Units sealed with two part sealants can be stacked; however, Edgetech recommends sealing without delay once the units have been matched.

Apply a ¼" (6.3mm) thick sealant amount behind the spacer when Polyurethanes or solvent-free Polysulfides are used.

6. Contamination

Absolutely no dust, dirt, PIB tape roll-up or other contaminants should be present on the glass in the sealant bond line area. All sealants are designed to adhere to clean dry glass only. Remove any debris before sealant application.

7. Corners

The corners of any insulating glass unit are very critical areas. Special attention must be given to ensure quality. Visually inspect and pack the corners and remove voids, skips or cold joints.

8. Sealant Quality Checks

Absolutely no blow bys, cold joints or voids should be in the sealant. Visually inspect for defects in the sealant and correct them. Care should be taken not to damage glass edges when applying sealants.

Correctly Sealed Unit

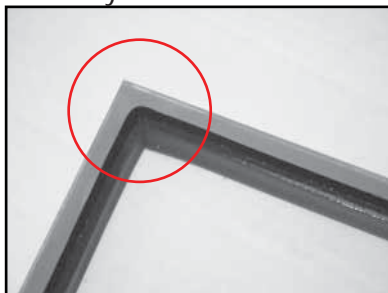

Blow by

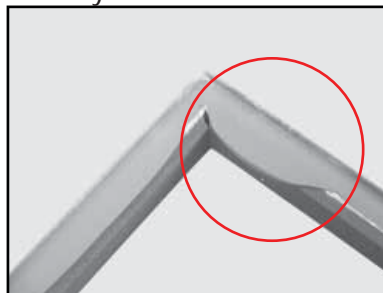

Cold Joint

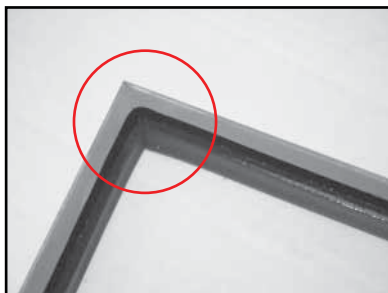

Void

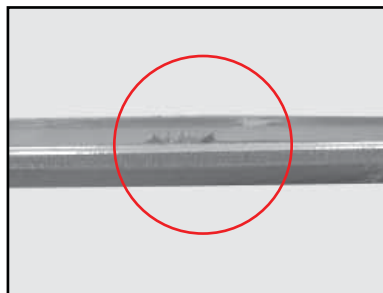

(this page intentionally left blank)

Recommended Sealant Compatibility List

Check this chart and compare products on the market. Here in one easy-to-read reference list, you can review the IG sealant brands and types that are compatible with Edgetech Spacer Systems.

Company	Hot Melt Butyl*	Curative Hot Melt*	Polysulfide**	Polyurethane**	Silicone*** For use with TriSeal™ only
Adco Products, Inc. Michigan Center, MI (800) 248-4010 www.adcoglobal.com	Adcotherm HMB				
Bostik Middleton, MA (978) 777-0100 www.bostikfindley-us.com	5190 Series	9190 Series		3190 Series	
PRC De-Soto Intl., Inc. Glendale, CA (818) 240-2060 www.ppg.com/prc-desoto/main.asp		PRC 590 PRC 591M PRC 591SB	PRC 469FM Permapol (modified PS)	PRC 4429 PRC 4429 HM	
Delchem Wilmington, DE (800) 441-7086 www.delchem.com	100 Series	D2000	80 Series	90 Series	
H.B. Fuller Company St. Paul, MN (888) 423-8553 www.hbfuller.com	Thermo-seal HM-1081A HM-1091 HM-1191 HL-5140 HL-5147 HL-5145	HL-5160C HL-5153B		UR-5100 Series (Available in a range of cure rates)	
CR Laurence Co., Inc. Los Angeles, CA (800) 421-6144 www.crlaurence.com	CRL 502 (slabs, 6 lb chunks, 36 lb blocks, 5-gal pails, 55-gal drums)			CRL N60055GL (Net 55-gal. Kit)	
Sommer & Maca Industries, Inc. Cicero, IL (708) 963-5446 www.somaca.com	H.B. Fuller — HM-1081 other related products				
Fenzi North America Toronto, Ontario Tel. (416) 674-3831 www.fenzi-na.com	HOTVER 2000		Thiover		
Dow Corning Corporation Midland, MI (989) 496-4400 www.dowcorning.com					982 (2 part) 3-0117 (1 part)
Momentive Performance Materials (formerly GE Silicones) Huntersville, NC (877) 943-7325 www.ge.com/silicones					IGS3713 (1 part)

* Recommended for achieving optimum Super Spacer reverse dual-seal properties. Super Spacer nXt™ is to be used only with Hot melt Butyl and Curative Hot Melt.

** Use of polysulfide and polyurethane secondary sealants with products other than Super Spacer T-Spacer / TriSeal may significantly reduce the durability performance of the insulating glass unit and is at the customer's discretion.

*** Silicone secondary sealants are to be used only with Super Spacer T-Spacer / TriSeal products.

The results of the compatibility testing are only valid as long as the supplier certifies that neither the formulation nor manufacturing process for these materials has been changed.

Sealants are evaluated on a regular basis. List may change with updates.

Proper workmanship is crucial to the quality and long-term durability of a Super Spacer® IG unit. Attention to detail during the production process is easy, straight forward, and the responsibility of every member of the production team.

1. Training

Training is a crucial element of producing quality Super Spacer IG units through acceptable workmanship practices. Edgetech I.G. provides this reference manual and on-site Super Spacer production training.

2. Quality Checks

Quality checks are essential for good workmanship. Inspection for vital details at each production station must be performed. This reference manual includes all the necessary elements to produce long lasting Super Spacer IG units.

3. Quality Audits

Edgetech conducts periodic quality audits. The audits cover every step of the production process from product handling to production efficiency.

4. Technical Service and Support

Edgetech's highly trained Technical Service staff provides a full line of customer support which includes spacer application training, Super Spacer IG production training, audits and audit follow-ups, equipment solutions, product and technical support for every customer. We are committed to helping you build quality units through excellent workmanship.

5. Your Commitment

Follow the recommended workmanship guidelines set forth in the reference manual and you will produce high quality, durable Super Spacer IG units.

(this page intentionally left blank)

Material inspection and quality control are an important part of Super Spacer® IG production. The following four tests should be carried out regularly: (1) visual inspection of packaging; (2) measurement of spacer width; (3) desiccant activity and (4) structural adhesion. These tests should be carried out at the start of each production day or when starting a new lot number.

1. Visual Inspection of Packaging

Box Condition

Inspect the cardboard box containing the Super Spacer material to ensure that it has not been damaged during shipping. Particular attention should be given to severe dents and punctures, which may indicate a problem of damaged goods. If the carton is damaged, Edgetech recommends using the desiccant activity test to ensure the desiccant level in the Super Spacer is acceptable.



Packaging Condition

Inspect the package bags protecting the product to see if there are any holes, rips or gaps in the film material.



2. Measurement of Spacer Width

Because Super Spacer is made from a flexible foam material, it is recommended that a small IG unit (approx. 6" x 6" or 150mm x 150mm) be first produced from a single length of material that is formed in a circular shape. The overall IG thickness is measured using calipers or similar equipment. The thickness of the two glass sheets is also measured using calipers, and the spacer width is then calculated by subtracting the two glass thickness measurements from the overall IG thickness. Check to confirm that the spacer is within the specified tolerances for the spacer size.



Please note that to obtain a size measurement, the calipers should not be applied directly to the spacer, and the plastic liner must be removed before placing the spacer between the two glass lites.

3. Desiccant Activity

Desiccant activity is determined indirectly by measuring the dew/frost point temperature of the samples test until that is used to measure the spacer width.

Initial Assessment of Desiccant Activity

For IG manufacturers who lack sophisticated equipment, an initial assessment of desiccant activity can be achieved using one of the following test methods: Desiccant Activity Test Kit and Sample units with a RH Indicator Card.

Desiccant Activity Test Kit

Edgetech has a Desiccant Activity Test Kit available. The kit should be used for the following:

- First package of each new lot.
- Previously opened packages of Super Spacer.
- Any unopened packages of Super Spacer older than 36 months.



RH Indicator Card

When fabricating the small sample IG unit, an RH indicator card is placed inside the unit. Within two hours, the pink circular spot should turn blue and match the color of the RH bar. These RH indicator cards are reversible and reusable and can be ordered directly from Edgetech IG Inc.

If a sample of Super Spacer fails any of the initial desiccant activity tests, 20ft (6m) of spacer material should be removed from the reel and the test should be repeated. If the material still fails, Edgetech's sales representatives should be contacted for further technical advice, or call Edgetech's Technical Services Department at 800-233-4383 or 740-439-2338 (outside North America). Super Spacer that does not pass cannot be used for production.

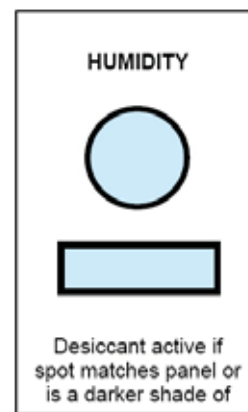

ASTM E-546 Dew Point Test

The two initial assessment test methods give a good indication of desiccant activity. However, for a more accurate determination of desiccant activity, perform the ASTM E-546 dew point test method.

One source for the ASTM test equipment is Dennis Industries, and they can be contacted at 301-428-0471 for more product information on their D-100 dew/frost-point apparatus. For Super Spacer material, the dew/frost-point of the sample unit should be measured after 24 hours.



4. Structural Adhesion

Obtain a (12" x 12") piece of glass and clean with window cleaner (minimum of three times).

Collect spacer samples and make sure they are a minimum of 6" long. Remove the liner from the sample and apply the sample to the clean glass. (Allow approximately 1" to hang over the edge of the glass so that you can remove it after 30 minutes to an hour.)

Apply samples with sufficient pressure to allow initial adhesion. Use your thumb to apply the pressure. Allow the samples to adhere to glass for 30 minutes to an hour.

After the allowed time frame, remove the samples one at a time by pulling the overhanging spacer upward at approximately a 90 degree angle from the surface of the glass while observing for the following "PASS" / "FAIL" criteria:

Pass Adhesive to Spacer foam tear

Fail Adhesive to spacer bond failure

Super Spacer that does not pass cannot be used for production.

In keeping with the high standards of quality at Edgetech IG, the following is our shelf life policy for Super Spacer:

The shelf life of Super Spacer is stated to be three years when sealed in the original packaging. It is very important to note that this shelf life applies to unopened boxes that are properly sealed.

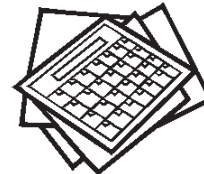

The results of the four quality control procedures should be systematically recorded, and a sample QC inspection form is shown below.

QC Inspection				Desiccant Foam Spacer						
Spacer Width: _____				Supplier: _____		Sign Off: _____				
Date	Product Identification			Condition of Packaging	Spacer Width Measured	Desiccant Activity		Structural Adhesive		Initial
	Edgetech Part No.	Serial No.	Production Date			Pass	Fail	Pass	Fail	

Inspection Frequency. a) When new package is opened; b) Once per week and every time a new container is opened.

Storage

The Super Spacer boxes should not be placed directly on the floor, especially concrete cement floors. It is advisable to store the Super Spacer on racks to minimize moisture intake.

Store Super Spacer boxes away from direct sunlight, in dry conditions preferably inside a building structure.

Before using a Super Spacer product that was stored in a very cold or hot environment, move it to normal operating room temperature at least 4 hours before production.

If the Super Spacer product is stored for more than 2 years, Edgetech recommends conducting the desiccant activity test. Edgetech will provide the simple tool to conduct this test free of charge.

(this page intentionally left blank)

Breakdown Reel Teardown

*Push down and outward on the tabs
Repeat on all 4 sets of tabs*



Remove one-half piece of the core



Remove the other half piece of the core



Correct



Incorrect





We're there for you at every turn! **3:0**

Contact Information

1 of 1

Edgetech I.G. Inc.
800 Cochran Avenue
Cambridge, Ohio 43725
www.superspacer.com

Main Phone: **740-439-2338**
Toll Free: **800-233-4383**
Fax: **740-439-0121**



We're there for you at every turn! **360**

800 Cochran Avenue • Cambridge, Ohio 43725
800.233.4383 • www.edgetechig.com